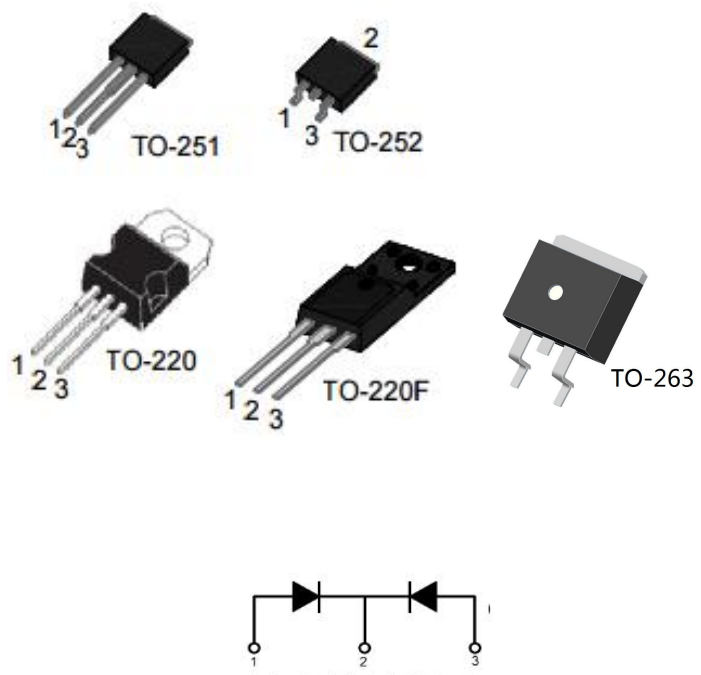

Schottky Barrier series Rectifiers Voltage Range 45 to 200 Volts Current 30.0 Amperes

<p>Features</p> <ul style="list-style-type: none"> Metal silicon junction, majority carrier conduction Low power loss, high efficiency High current capability, low forward voltage drop High surge capability For use in low voltage, high frequency inverters, free wheeling, and polarity protection applications Guardring for overvoltage protection High temperature soldering guaranteed: 260°C/10 seconds, 0.25" (6.35mm) from case <p>Mechanical Data</p> <ul style="list-style-type: none"> Cases: TO-220 molded plastic body Terminals: Lead solderable per MIL-STD-750, Method 2026 Polarity: As marked Mounting position: Any Mounting torque: 5 in. - lbs. max 	 <p style="text-align: center; font-size: small;">1. Anode 2. Cathode 3. Anode</p>
--	--

Maximum Ratings and Electrical Characteristics

Type Number	Symbol	MBR 3045CT	MBR 3060CT	MBR 30100CT	MBR 30150CT	MBR 30200CT	Units
Maximum Recurrent Peak Reverse Voltage	V_{RRM}	45	60	100	150	200	V
Maximum RMS Voltage	V_{RMS}	31	42	70	115	160	V
Maximum DC Blocking Voltage	V_{DC}	45	60	100	150	200	V
Maximum Average Forward Rectified Current (Dan Guan)	$I_{(AV)}$	15					A
Maximum Average Forward Rectified Current (double))	$I_{(AV)}$	30					A
Peak Forward Surge Current, 8.3 ms Single Half Sine-wave Superimposed on Rated Load (JEDEC method)	I_{FSM}	250					A
Peak Repetitive Reverse Surge Current (Note 1)	I_{RRM}	2		1			A
Voltage Rate of Change (Rated VR)	dv/dt	1000					V/uS
Maximum Instantaneous Forward Voltage at IF=15A, Tc=25°C	V_F	0.65	0.75	0.85	0.90	0.95	V
IF=15A, Tc=125°C		0.55	0.65	0.75	0.80	0.85	V
IF=30A, Tc=25°C		0.90	0.95	1.1	1.2	1.25	V
Maximum Instantaneous Reverse Current @ Tc =25°C at Rated DC Blocking Voltage (Note 2)	I_R	100					uA
@ Tc=125°C		15		10		5	mA
Typical Junction Capacitance	C_j	410	300	300	150	110	pF
Operating Junction Temperature Range	T_J	-50 to +150					°C
Storage Temperature Range	TSTG	-65 to +175					°C

Notes: 1. 2.0us Pulse Width, f=1.0 KHz
2. Pulse Test: 300us Pulse Width, 1% Duty Cycle

THERMAL RESISTANCES

Symbol	Parameter	Value	Unit
Rth(j-c)	junction to case(AC)	TO-251/252	3.8
		TO-220	2.1
		TO-220F	4.1

PACKAGE MECHANICAL DATA

TO-220

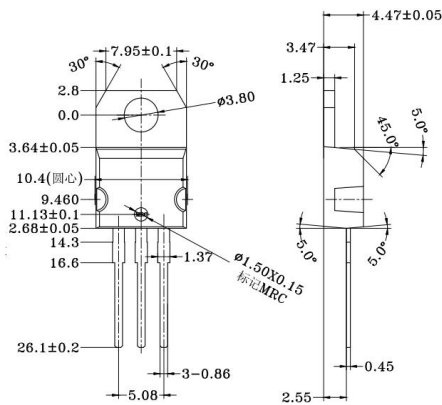

TO-252

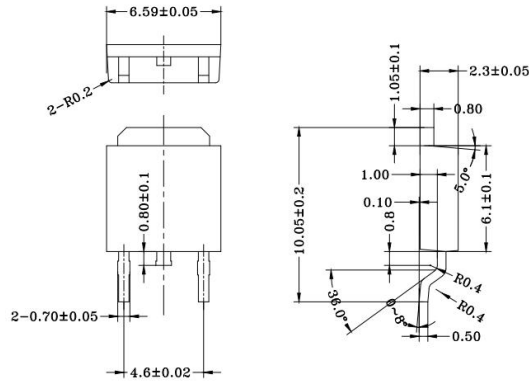

TO-251

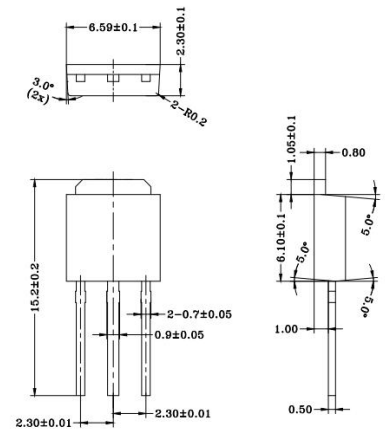

TO-22F

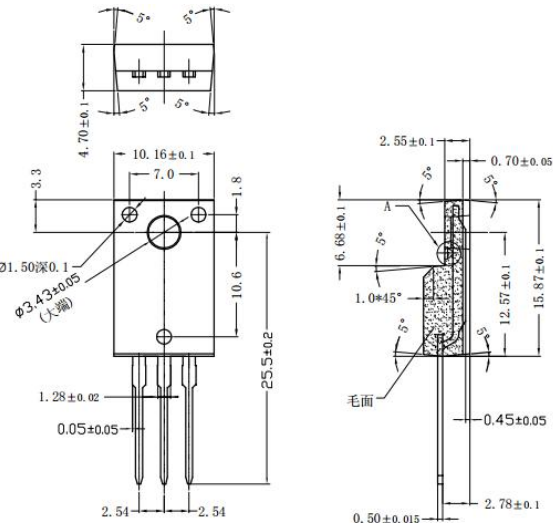

TO-263

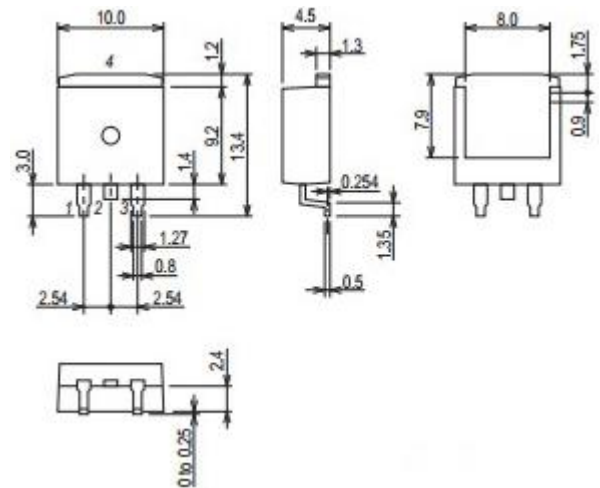

RATINGS AND CHARACTERISTIC CURVES (MBR3045CT THRU MBR30200CT)

TYPICAL JUNCTION CAPACITANCE PER LEG

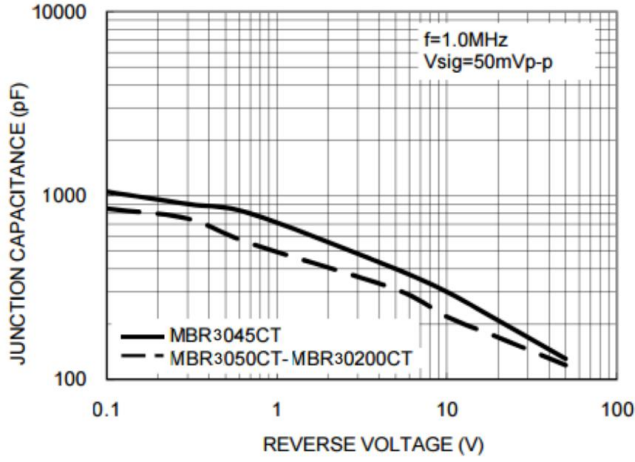

TYPICAL TRANSIENT THERMAL IMPEDANCE PER LEG

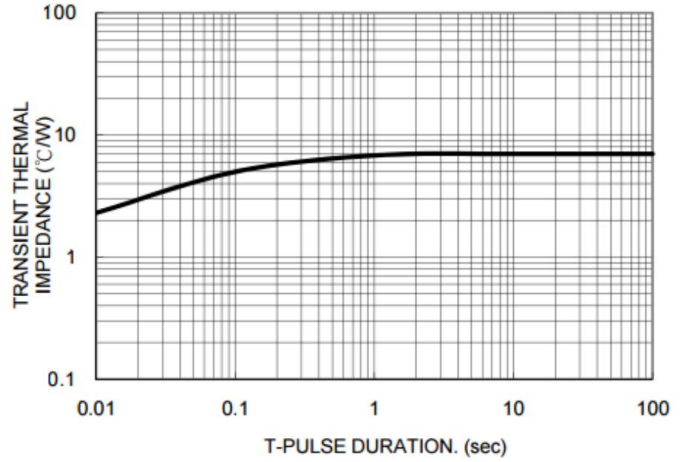

TYPICAL INSTANTANEOUS FORWARD CHARACTERISTICS PER LEG

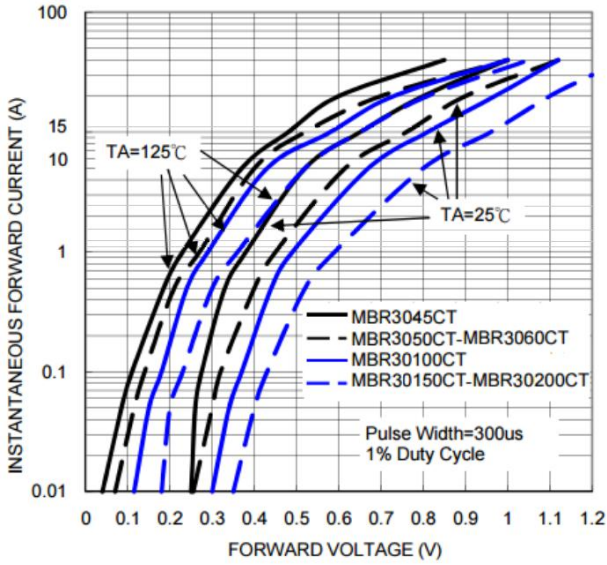

TYPICAL REVERSE CHARACTERISTICS PER LEG

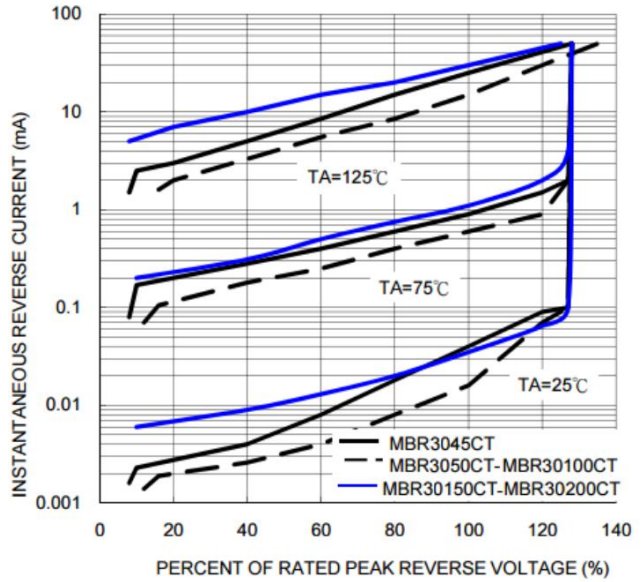

FORWARD CURRENT DERATING CURVE

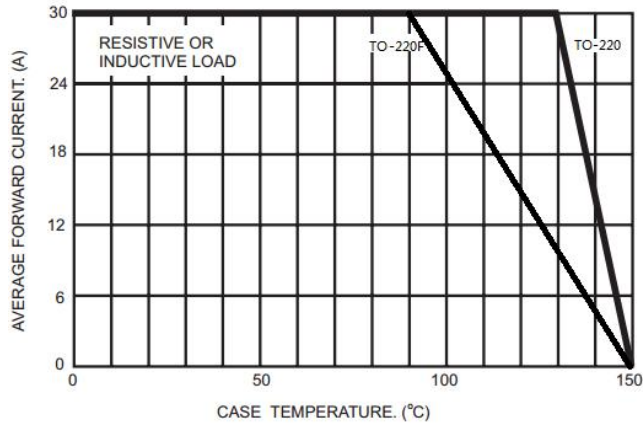

MAXIMUM NON-REPETITIVE FORWARD SURGE CURRENT PER LEG

