

MUR1610CT, MUR1615CT, MUR1620CT, MUR1640CT, MUR1660CT

FEATURES

- High speed switching
- Glass passivated chip junction
- Low power loss, high efficiency
- Low leakage
- High surge capacity
- High temperature soldering guaranteed
250°C/10 second, 0.16" (4.06mm) lead length
- Also available with common Anode, add an "T" suffix, i.e. MUR1610CT, and as a doubler, add a "TA" suffix, i.e. MUR1601CTA
- Also available in an isolated package, MURF1610CT
- Also available in the single chip version, MUR1610

MECHANICAL DATA

- Case: Transfer molded plastic
- Epoxy: UL94V-0 rate flame retardant
- Lead: Solderable per MIL-STD-202E method 208C
- Polarity: as Marked
- Mounting position: Any, 5 in-lbs Torque Max
- Weight: 0.08 ounce, 2.24 gram

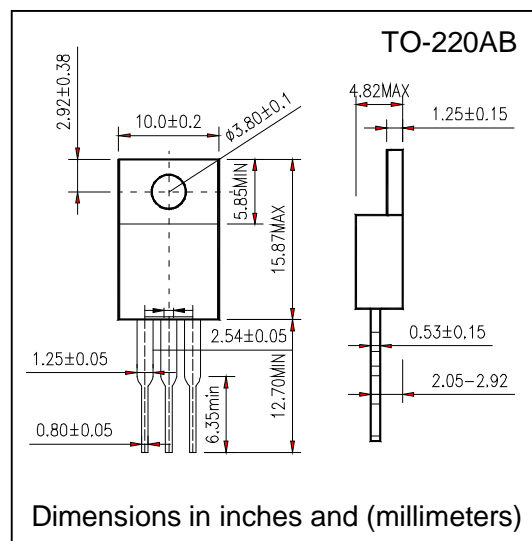

MAXIMUM RATINGS

Rating	Symbol	MUR16					Unit
		10CT	15CT	20CT	40CT	60CT	
Peak Repetitive Reverse Voltage Working Peak Reverse Voltage DC Blocking Voltage	V_{RRM} V_{RWM} V_R	100	150	200	400	600	V
Average Rectified Forward Current Total Device, (Rated V_R), $T_C = 150^\circ\text{C}$	$I_{F(AV)}$ Per Leg Total Device	8.0 16					A
Peak Rectified Forward Current (Rated V_R , Square Wave, 20 kHz), $T_C = 150^\circ\text{C}$	I_{FM} Per Diode Leg	16					A
Nonrepetitive Peak Surge Current (Surge applied at rated load conditions halfwave, single phase, 60 Hz)	I_{FSM}	100					A
Operating Junction Temperature and Storage Temperature	T_J, T_{stg}	- 65 to +175					$^\circ\text{C}$

Stresses exceeding Maximum Ratings may damage the device. Maximum Ratings are stress ratings only. Functional operation above the Recommended Operating Conditions is not implied. Extended exposure to stresses above the Recommended Operating Conditions may affect device reliability.

THERMAL CHARACTERISTICS (Per Diode Leg)

Parameter	Symbol	Value		Unit
Maximum Thermal Resistance, Junction-to-Case	$R_{\theta JC}$	3.0	2.0	$^\circ\text{C/W}$

ELECTRICAL CHARACTERISTICS (Per Diode Leg)

Characteristic	Symbol	1620	1640	1660	Unit
Maximum Instantaneous Forward Voltage (Note 1) ($i_F = 8.0\text{ A}$, $T_C = 150^\circ\text{C}$) ($i_F = 16.0\text{ A}$, $T_C = 25^\circ\text{C}$)	V_F	0.895 1.00	1.00 1.30	1.20 1.68	V
Maximum Instantaneous Reverse Current (Note 1) (Rated DC Voltage, $T_C = 150^\circ\text{C}$) (Rated DC Voltage, $T_C = 25^\circ\text{C}$)	i_R	250 5.0	600 10		μA
Maximum Reverse Recovery Time ($I_F = 1.0\text{ A}$, $di/dt = 50\text{ A}/\mu\text{s}$) ($I_F = 0.5\text{ A}$, $I_R = 1.0\text{ A}$, $I_{REC} = 0.25\text{ A}$)	t_{rr}	50 30	75 50		ns

1. Pulse Test: Pulse Width = 300 μs , Duty Cycle $\leq 2.0\%$

MUR1610CT. MUR1615CT. MUR1620CT

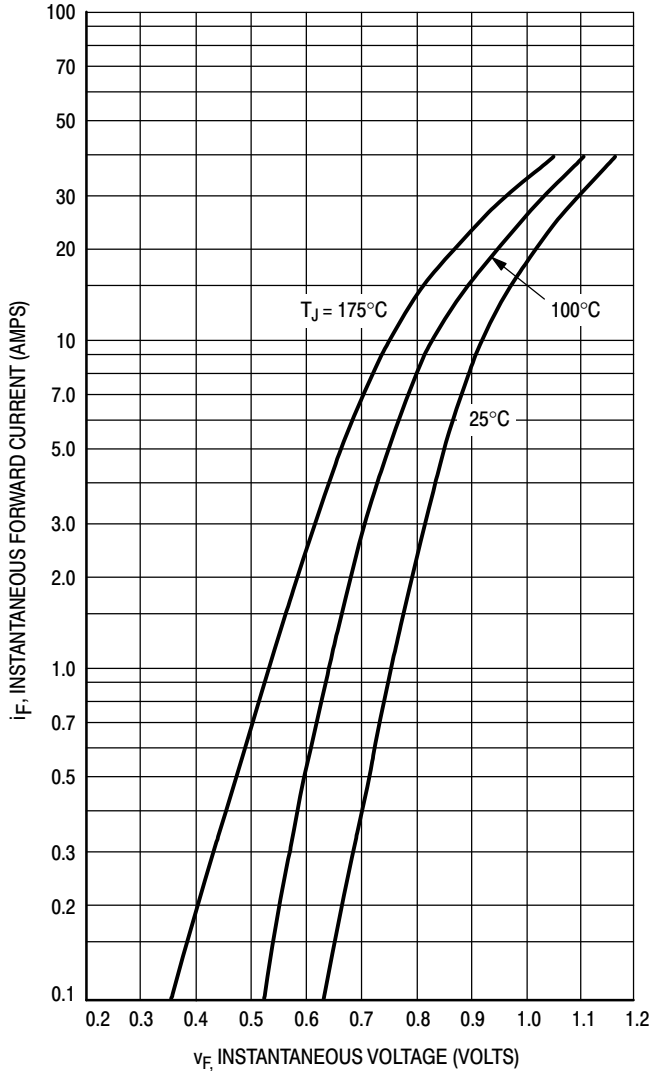

Figure 1. Typical Forward Voltage, Per Leg

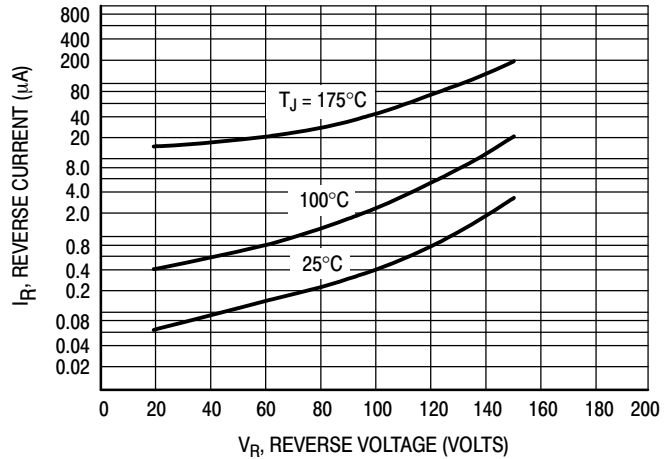

Figure 2. Typical Reverse Current, Per Leg*

* The curves shown are typical for the highest voltage device in the voltage grouping. Typical reverse current for lower voltage selections can be estimated from these same curves if V_R is sufficiently below rated V_R .

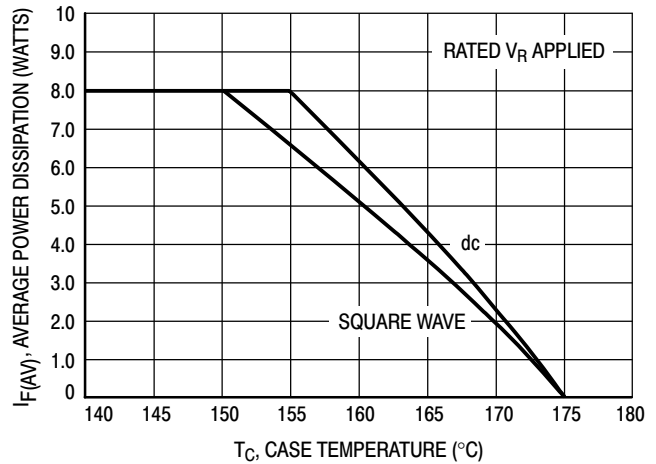

Figure 3. Current Derating, Case, Per Leg

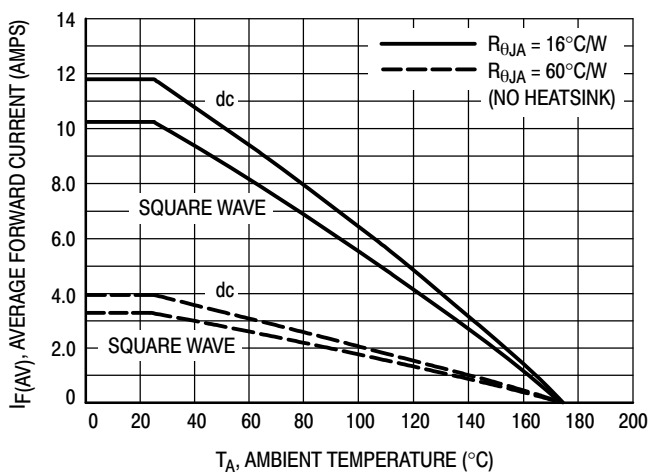

Figure 4. Current Derating, Ambient, Per Leg

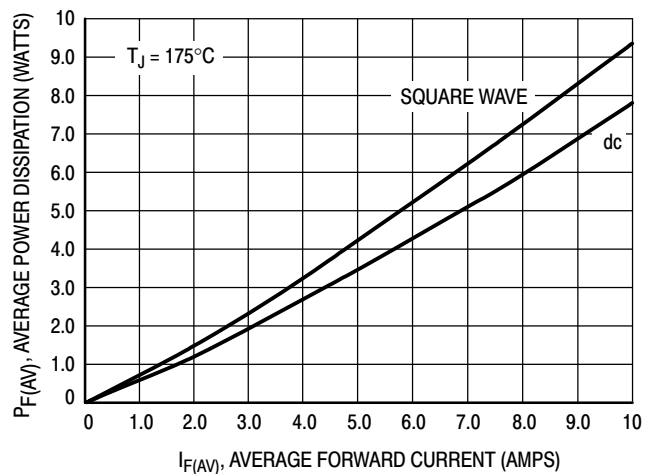

Figure 5. Power Dissipation, Per Leg

MUR1640CT

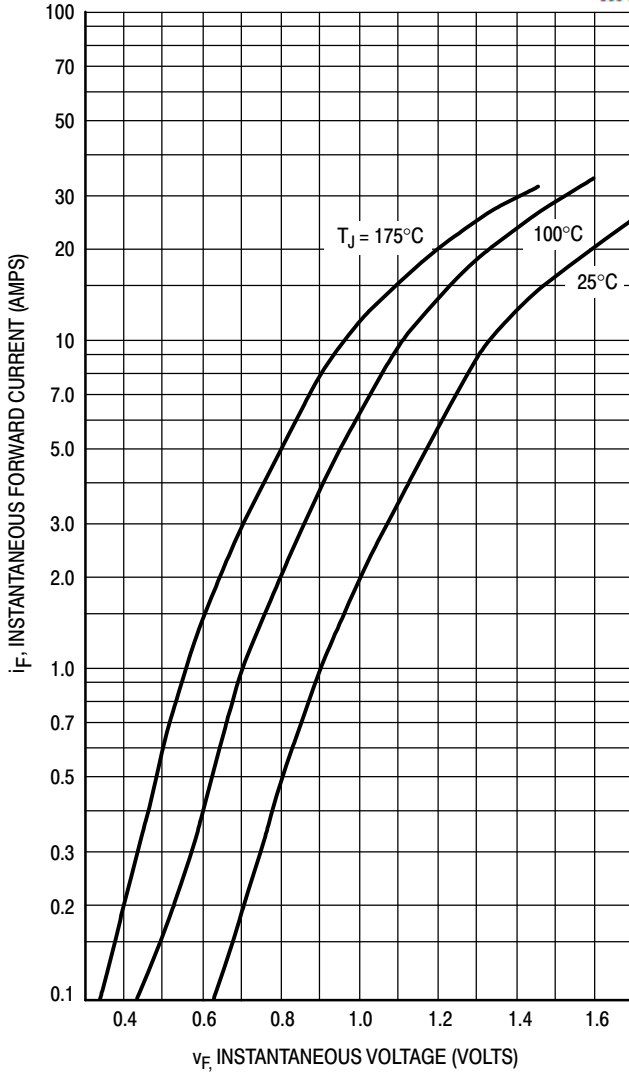

Figure 6. Typical Forward Voltage, Per Leg

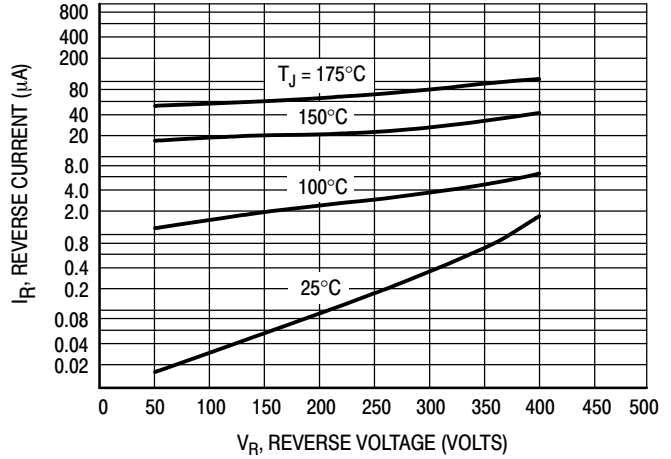

Figure 7. Typical Reverse Current, Per Leg*

* The curves shown are typical for the highest voltage device in the voltage grouping. Typical reverse current for lower voltage selections can be estimated from these curves if V_R is sufficiently below rated V_R .

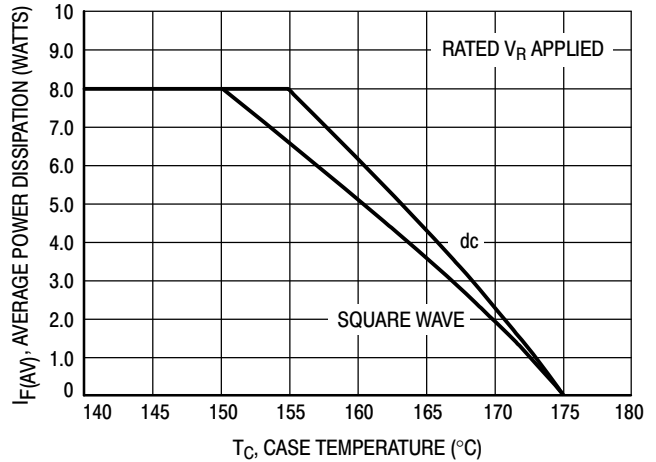

Figure 8. Current Derating, Case, Per Leg

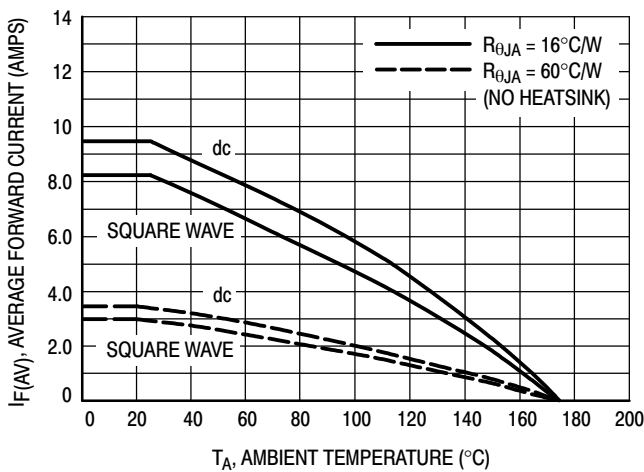

Figure 9. Current Derating, Ambient, Per Leg

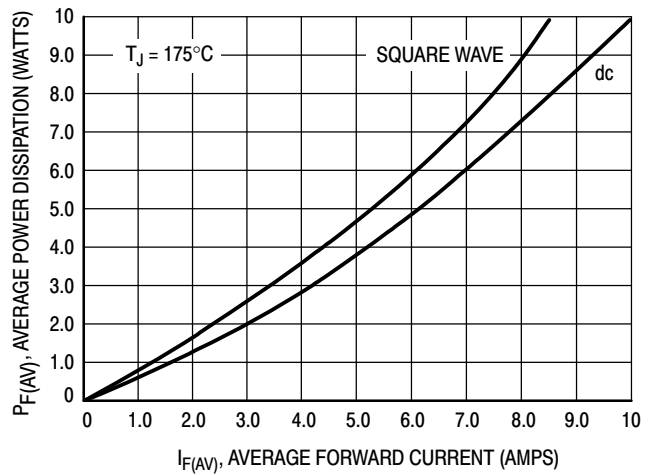

Figure 10. Power Dissipation, Per Leg

MUR1660CT

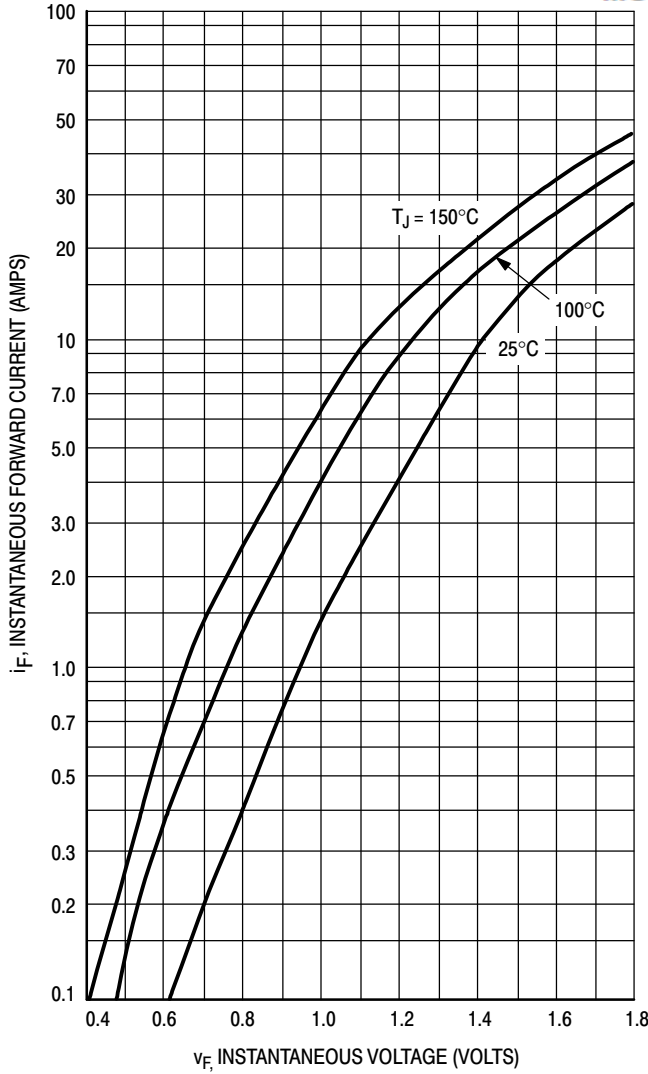

Figure 11. Typical Forward Voltage, Per Leg

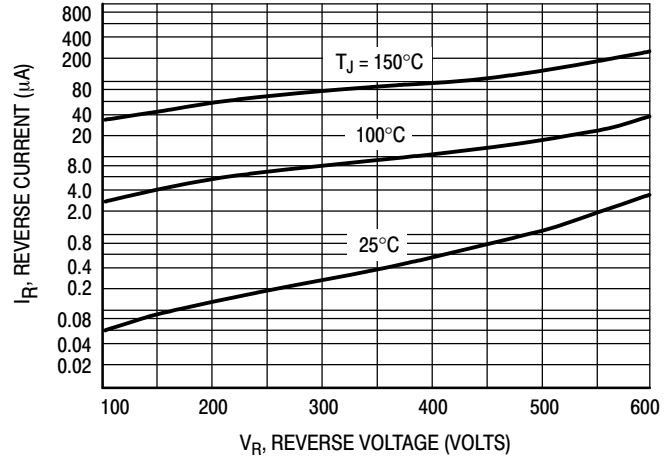

Figure 12. Typical Reverse Current, Per Leg*

* The curves shown are typical for the highest voltage device in the voltage grouping. Typical reverse current for lower voltage selections can be estimated from these same curves if V_R is sufficiently below rated V_R .

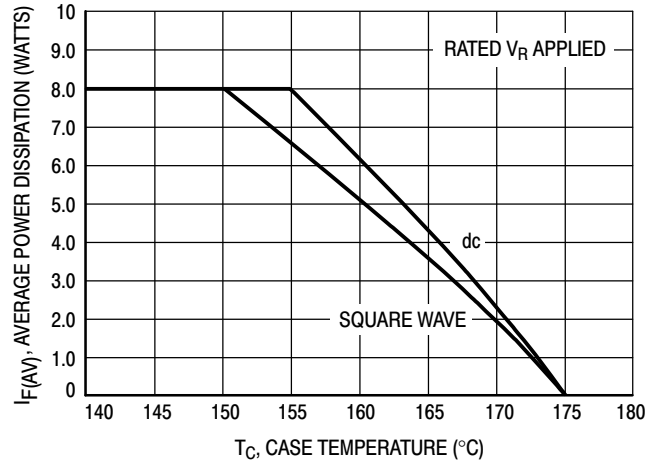

Figure 13. Current Derating, Case, Per Leg

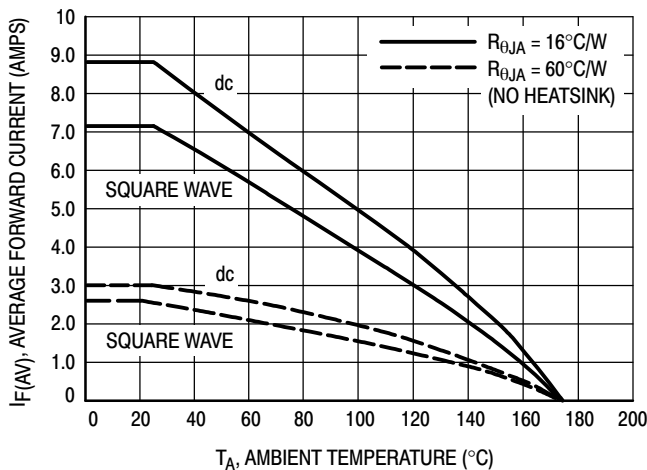

Figure 14. Current Derating, Ambient, Per Leg

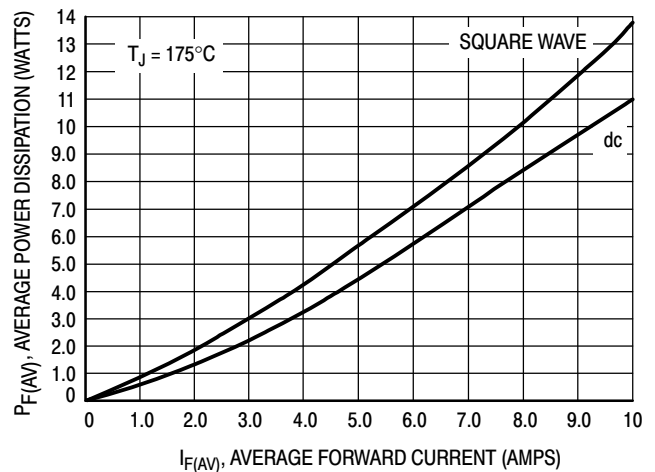

Figure 15. Power Dissipation, Per Leg

MUR1610CT, MUR1615CT, MUR1620CT, MUR1640CT, MUR1660CT

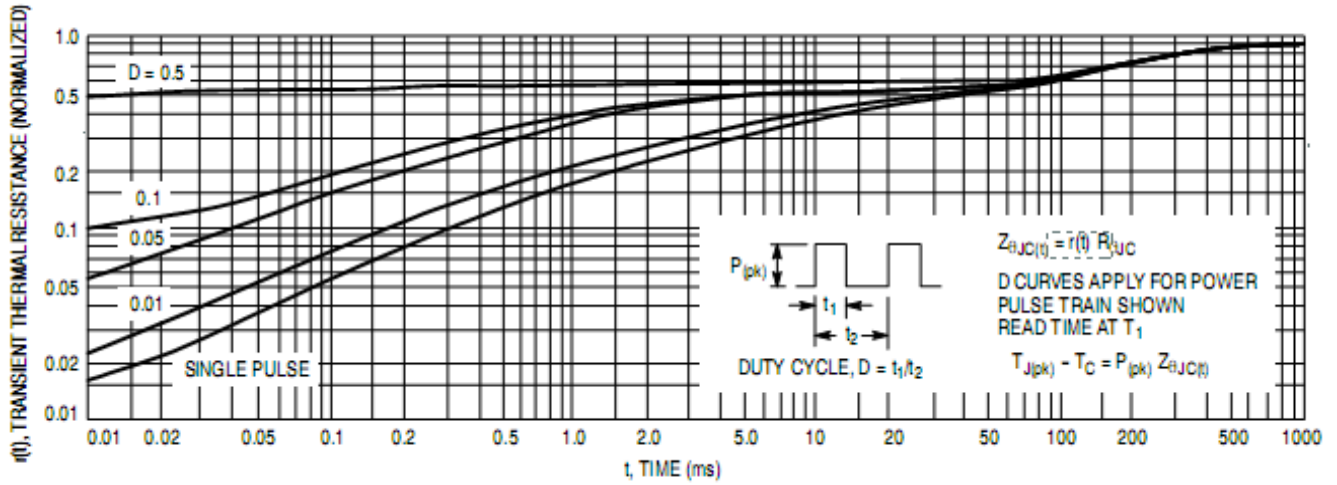

Figure 16. Thermal Response

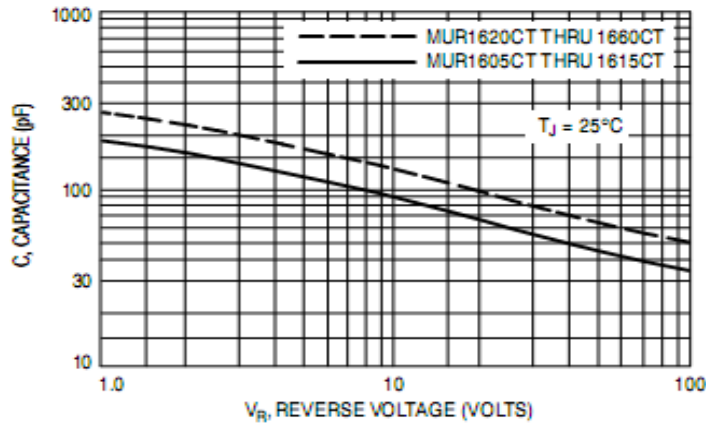

Figure 17. Typical Capacitance, Per Leg